

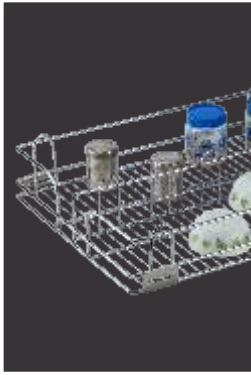



*Crafting happiness in life...*



**CRAFT**<sup>®</sup>  
*Crafting Happiness*

KITCHEN | WARDROBE | BATHROOM ACCESSORIES



## *Crafting happiness in life...*

**CRAFT Product Line** is a presentation of Kitchen and Utility apparatus that combines aesthetics with economy and achieves long term excellence in terms of longevity and utilization.

The primary motive fueling the CRAFT Product Line is to assemble utility appliances that optimize accessibility while minimizing the space wastage. CRAFT Products are designed for the urban architecture, tailor made to make full use of the space available.

The salient aspect of CRAFT Product line lies in the versatility of the product. Every unit is not only customizable but also unique in providing storage solutions beyond the obvious. CRAFT Products are designed with the idea that one solution provides pathway to modify and satisfy a variety of customer needs.

The CRAFT Product Line extends from minimalist Kitchen Baskets and Racks to Multi-purpose Wardrobe options to Bathroom Utility Units. Creating Excellence through the symphony orchestrated between Design and Diligence.

## INDEX

Ladder Storage & Corner Solutions	02
Craft Diamond Baskets	12
Hanging & Multipurpose Accessories	26
Bathroom Accessories	36
Wardrobe Accessories	38

# Ladder Storage and Corner Solutions

## Pullout Section

### LARGE PANTRY PULLOUT

The CRAFT Large Pantry System Design is the universal solution designed to keep in mind both the encompassing aspects of the storage and nuances of Accessibility. The Pullout Sliding System allows instantaneous access to your storage while the economical design allows minimal space wastage

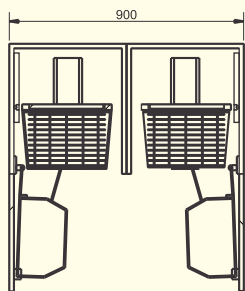
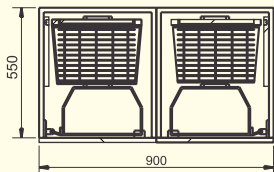

NOTE : ALL THIS SIZE ARE CAR CASE SIZE IN MM

Width	Depth	Height
33	21	4ft. & 6ft.

(Basket Size in Inches)



## PANTRY & MINI PANTRY PULLOUT

The Craft Pantry Pullout (Mini) combines the aesthetic marvel of minimalism which utilitarian nature of storage requirement and provides a complete solution that fits perfectly with your interior. A sturdy structure with heavy duty connectors, adjustable basket heights and runners frame, well suited for varied uses.

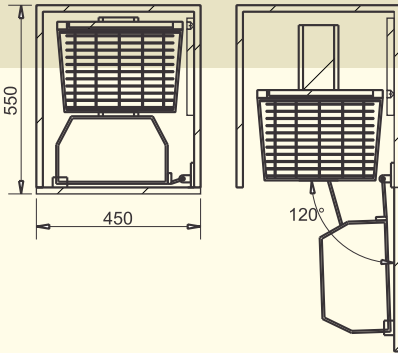

NOTE : ALL THIS SIZE ARE CAR CASE SIZE IN MM



**Mini Pantry Pullout**

Width	Depth	Height
17	21	18

(Basket Size in Inches)



**Pantry Pullout**

Width	Depth	Height
16	21	4ft. & 6ft.

(Basket Size in Inches)

## TALL UNIT

The Craft Tall Units are the premium class designs utilizing the vertical space available in the interiors to their optimal level while creating horizontal storage options for multiplied access. Used for both Utensils and Produce, the space matrix of Craft Tall Units is designed for longevity.

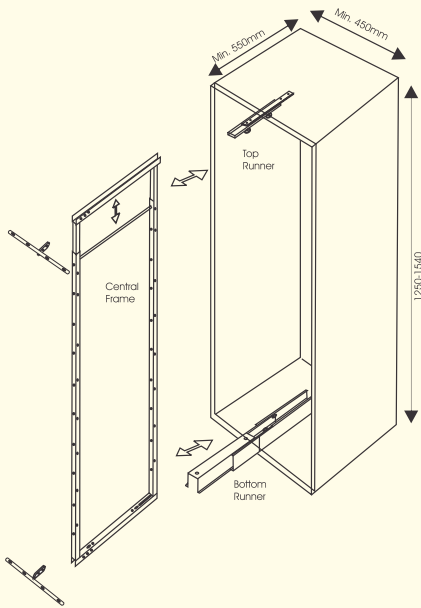

NOTE : ALL THIS SIZE ARE CAR CASE SIZE IN MM

### Tall Unit

Width	Depth	Height
16	21	4ft. & 6ft.

(Basket Size in Inches)



## CAROUSEL UNIT (270°)

Taking advantage of the perpendicular kitchen design, the CRAFT Carousel Unit can be installed in the corner spaces to increase efficiency with style. A snug fit, aesthetic designed to provide complete satisfaction with its variety of diameter sizes.

The Craft Carousel Unit is a 90-Degree orientation installation for kitchen interiors that focuses on external space utilization and internal storage maximization for efficient and style kitchens.



- Dia
- 18
  - 20
  - 22
  - 24
  - 26
  - 28
  - 30

(Size in Inches)

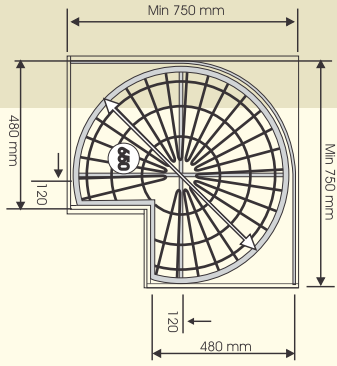

## DEE TRAY

The Craft Dee Tray is designed in lateral proportions to provide maximum storage surface while minimizing the space wastage in its installation, aligned perfectly along the planes of walls and providing stable structure for day to day needs of a kitchen storage.



- Dia
- 24
  - 26
  - 28
  - 30

(Size in Inches)

## CAROUSEL FULL ROUND

The Craft Full Round Carousel is constructed with a 360-Degree rotational core that is embedded within a strong alloy frame to create the high-functional storage systems for all needs possible.



- Dia
- 12
  - 14
  - 16
  - 18
  - 20

(Size in Inches)

## MAGIC CORNER (Universal)

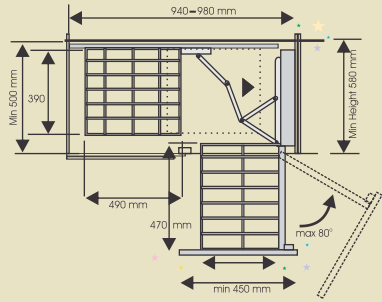

NOTE : ALL THIS SIZE ARE CAR CASE SIZE IN MM

The Craft Magic Corner is a leading fixed corner space installation that maximizes on user friendliness and stability of structure. Aesthetically pleasing finish with utilitarian design mold.

### Magic Corner (Universal)

Width	Depth	Height
36	21	27

(Basket Size in Inches)

## MAGIC CORNER (Double Pullout)

The Craft Corner (Double- Pullout) is designed for maximum bulk storage and combines the signature Craft creativity of pullout adjustable baskets in its features to provide expanded storage solution in a single unit.

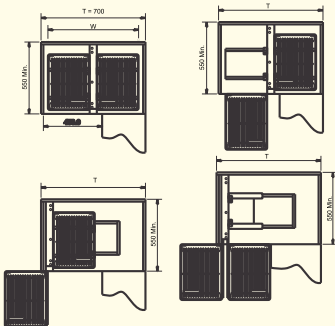

NOTE : ALL THIS SIZE ARE CAR CASE SIZE IN MM



### Magic Corner Double Pull-out

Width	Depth	Height
26	21	24

(Basket Size in Inches)

## S - CAROUSEL



### S - Carousel

Width	Depth	Height
33	21	24-28

(Basket Size in Inches)

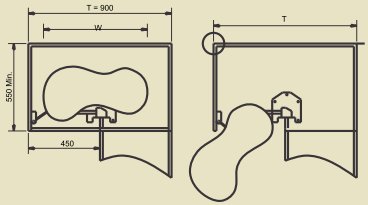

LEFT S-CAROUSEL

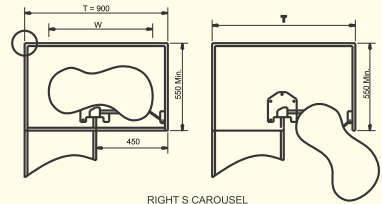

RIGHT S-CAROUSEL

NOTE : ALL THIS SIZE ARE CAR CASE SIZE IN MM

## MAGIC CAROUSEL (Revolving)

The Craft Magic Carousel is a 360-Degree Rotational Module that comprises of customizable basket arrangement and a corner space utilization design that allows for the universal storage solution. Easy to Install and Highly Customizable.

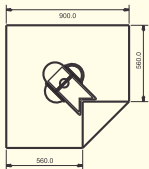

CLOSED VIEW - 1

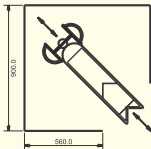

PULLOUT VIEW - 2

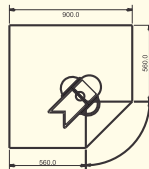

ROTATING VIEW - 3



### Magic Carousel

Width	Depth	Height
34x34	21	24-28

(Basket Size in Inches)

NOTE : ALL THIS SIZE ARE CAR CASE SIZE IN MM

## BASKET WITH QUADRO FITTING

Customization is an important part of customer satisfaction. The Baskets come enhanced with Quadro channel fittings to ensure that the storage space is both versatile and maximized to ensure complete quality performance.

The Craft Basket with Quadro Fitting incorporates Quadro Channel Design to provide an easy and flexible storage solution for the urbane Kitchen needs.

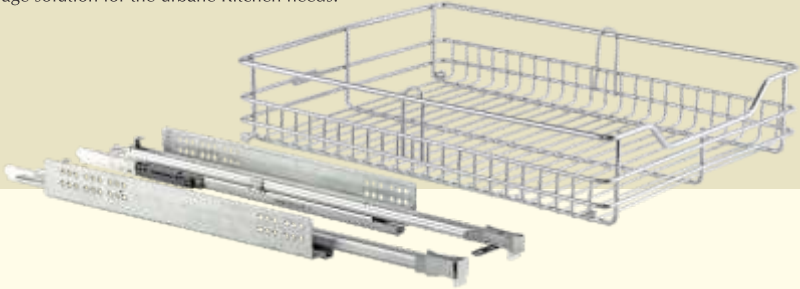

Width	Depth	Height
15	20	4 6 8
17	20	4 6 8
19	20	4 6 8
21	20	4 6 8

(Size in Inches)

## ACCESSORIES

All CRAFT Solutions are enhanced with installation accessories to ensure maximum quality performance and long term utility.





## OUR STORY



The Craft Product Line was an intention given shape. The intention to design a storage unit catalogue that not only caters to the primary needs of accessibility and utility, but also to provide the perfect amalgamation of space and design. The units were conceptualized and designed keeping in mind the economy of the space in contrast to the versatility of requirement.



As an Interior Designer, a primary reason to recommend Craft Product line is the minimalist unobtrusive aesthetic that not only provides a perfect assimilation into the Kitchen arrangements but also surpasses the contemporary storage assembly by providing a sleek design that allows the consumer the ease of access.



I was recommended to install the Craft Product Line in my Kitchen by my interior Designer. At the very first impression, what took me by surprise was how convenient the dimensions and fittings were. The installation was far smoother and quicker than any I've previously seen and yet did not take up all the space in the kitchen. I like to move around a bit in my kitchen when I cook and Craft Product Line is the perfect solution for using space economically while allowing superb accessibility to the storage.

---

**Er. Rahul Sharma**  
Product Designer

**Shikha Jain**  
Interior Designer

**Gurmeet Kuar**  
Homemaker & a CRAFT user

# LADDER STORAGE & CORNER SOLUTIONS

## SINGLE PULLOUT (Adjustable Basket)

The Craft Pullout Units allow the variety of Adjustable and Fixed Basket modules to choose as per your requirement. Designed for Standard size bottles, jars and grocery packs, the frame is a stable structure with focus on multi-faceted storage solutions.

**Multi Purpose Single Pullout (With Channel)**

Width	Depth	Height
4	16 20 22 24	24
6	16 20 22 24	24
8	16 20 22 24	24

(Size in Inches)



**Multi Purpose Detergent Pullout (With Channel)**

Width	Depth	Height
4	16 20 22 24	21
6	16 20 22 24	21
8	16 20 22 24	21

(Size in Inches)



## SINGLE PULLOUT (Fix Basket)

(Fix Basket)

Width	Depth	Height
4	20	17
6	20	17
8	20	17

(Size in Inches)



Width	Depth	Height
4	20	21
6	20	21
8	20	21

(Size in Inches)

## UTILITY PULLOUT

The Craft Utility Pullout, true to its name, is the ultimate utility installation for an urban kitchen. Ability to store standard sized utensils and providing perfect accessibility.



Width	Depth	Height
12	20	17 21
15	20	17 21

(Size in Inches)

## MECHANISM PULLOUT

The Craft Mechanism Pullout is a 3-tier storage space to ensure proportional space management for year round and seasonal storage customization settings, providing perfect design for various sizes of jars, bottles and jugs.



Width	Depth	Height
4	20	21
6	20	21
8	20	21

(Size in Inches)



Width	Depth	Height
4	20	24
6	20	24
8	20	24

(Size in Inches)

# CRAFT DIAMOND BASKETS

New Aluminum Based Material

## PLAIN BASKET

1. A minimalist 1-Tier Basket Rack with a secure structural design to provide perfect storage for utensils, cutlery and crockery. The primary installation to add to a modern kitchen.

2. The two-tier storage design for expanded and stable storage for the general utensils and crockery. Provides perfect storage space for versatile utensils.



### Features

- New era designer kitchen basket
- Aluminum based material with stainless steel pipe providing strength and long life.
- Easy to fit and use

Width	Depth	Height
15	20	4 6 8
17	20	4 6 8
19	20	4 6 8
21	20	4 6 8

(Size in Inches)



## Plate Basket



The Craft Plate Basket is an utensil storage installation with raised arch structures to provide stability and security for a large number of utensils. Efficient design ensures negligible damage to utensils.

Width	Depth	Height
15	20	6 8
17	20	6 8
19	20	6 8
21	20	6 8

(Size in Inches)

## Thali Basket



The Craft Thali Basket is the behemoth structure installation to uphold the utensils in place with perfectly dimensional arches for Thalis and Platters to provide accessible space, keeping in mind the frequently used nature of the stored products.

Width	Depth	Height
15	20	6 8
17	20	6 8
19	20	6 8
21	20	6 8

(Size in Inches)

## CUP & SAUCER BASKET

The Craft Cup and Saucer Basket structure extends the product range with the combination of arch designs for proper security of delicate crockery and cutlery and ease of access.  
Size Range 15 x 20 inches – 21 x 20 inches



Width	Depth	Height
15	20	4
17	20	4
19	20	4
21	20	4

(Size in Inches)

## CUTLERY BASKET

The Craft Cutlery Basket design accomplishes a perfect synchronization between organization and aesthetic perfection that provides complete hassle free access for your spoons, knives and forks.



Width	Depth	Height
15	20	4
17	20	4
19	20	4
21	20	4

(Size in Inches)

## Bottle Pullout

Presenting the perfect solution to organizing the host of bottled delicacies and liquids without bothering about space or access. The Bottle Pullout is an easy retractable/accessible utility rack that allows a two-tiered storage space for bottles of various heights with the top shelf for shorter bottles and the lower shelf with a tall bottles storage height. Available in sizes ranging from 4 to 8 inch, now chill in the heat with just a pull.



## Fitting Accessories

The Craft Diamond Baskets are designed in order to be a user-friendly product. A key point feature of the product range is the easy-to-install mode which allows minimal hassle and immediate utility initiation. Aided capably by the range of fitting accessories of brackets, nuts, bolts and screws, the Craft Diamond Basket is assured to be securely stable and providing long term customer satisfaction.



Width	Depth	Height
4	20	17
6	20	17
8	20	17

(Size in Inches)

Width	Depth	Height
4	20	21
6	20	21
8	20	21

(Size in Inches)

# PLAIN BASKET

The Craft Plain Basket, contrary to its name, hosts a plethora of user-friendly attributes such as a non-toxic structural alloy, sheet base and wire base variations and sizes ranging from 9 inches to 21 inches. Present and Customizable modules available for the customer satisfaction.



Width	Depth	Height
15	20	4 6 8
17	20	4 6 8
19	20	4 6 8
21	20	4 6 8

(Size in Inches)

Platinum WDH Available in Sheet & Wire Base



Width	Depth	Height
9	20 22 24	4 6 8
12	20 22 24	4 6 8
15	16 20 22 24	4 6 8
17	20 22 24	4 6 8
19	20 22 24	4 6 8
21	20 22 24	4 6 8

(Size in Inches)

Premium WDH



Width	Depth	Height
9	20 22 24	4 6 8
12	20 22 24	4 6 8
15	16 20 22 24	4 6 8
17	20 22 24	4 6 8
19	20 22 24	4 6 8
21	20 22 24	4 6 8

(Size in Inches)

Gold WDH



## PARTITION BASKET

The Craft Partition Basket is a versatility upgrade that introduces compartmentalization. The Partitions are designed to provide all-over storage space solution for a variety of utensils and materials and are offered in sizes from 9 to 21 inches.



Width	Depth	Height
15	20	4 6 8
17	20	4 6 8
19	20	4 6 8
21	20	4 6 8

(Size in Inches)



Platinum WDH Available in Sheet & Wire Base

Width	Depth	Height
9	20 22 24	4 6 8
12	20 22 24	4 6 8
15	16 20 22 24	4 6 8
17	20 22 24	4 6 8
19	20 22 24	4 6 8
21	20 22 24	4 6 8

(Size in Inches)

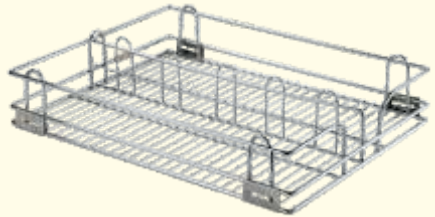

Premium WDH

Width	Depth	Height
9	20 22 24	4 6 8
12	20 22 24	4 6 8
15	16 20 22 24	4 6 8
17	20 22 24	4 6 8
19	20 22 24	4 6 8
21	20 22 24	4 6 8

(Size in Inches)

Gold WDH

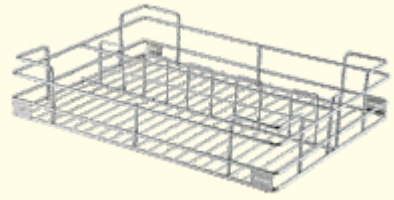

## CUP & SAUCER BASKET

The Craft Cup and Saucer Basket is the perfect installation for an urban kitchen and especially for the beverage connoisseurs who prefer their containers and mugs pristine. Drip and Dry feature, segregated features and size variety of 12 to 21 inches means a perfect cup of coffee awaits.



Width	Depth	Height
15	20	4
17	20	4
19	20	4
21	20	4

(Size in Inches)

Platinum WDH Available in Sheet & Wire Base

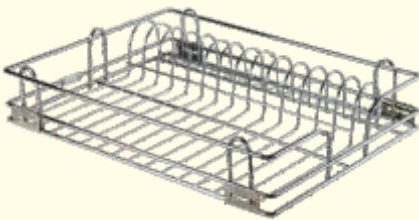

Width	Depth	Height
12	20	4
15	16 20 22 24	4
17	20 22 24	4
19	20 22 24	4
21	20 22 24	4

(Size in Inches)

Premium WDH



Width	Depth	Height
12	20	4
15	16 20 22 24	4
17	20 22 24	4
19	20 22 24	4
21	20 22 24	4

(Size in Inches)

Gold WDH

## CUTLERY BASKET

The Craft Wired Cutlery Basket can be installed adjacent to Cooking/cutting area in the kitchen to provide perfect accessibility for efficient kitchen arrangement and experience. Completely user-friendly and in variety of sizes from 12 to 21 inches.



Width	Depth	Height
15	20	4
17	20	4
19	20	4
21	20	4

(Size in Inches)

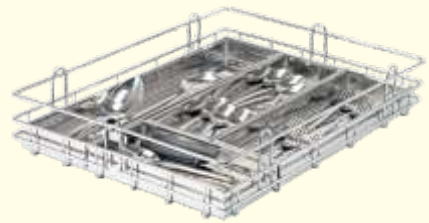

Platinum WDH Available in Sheet & Wire Base

Width	Depth	Height
12	20	4
15	16 20 22 24	4
17	20 22 24	4
19	20 22 24	4
21	20 22 24	4

(Size in Inches)



Premium WDH

Width	Depth	Height
12	20	4
15	16 20 22 24	4
17	20 22 24	4
19	20 22 24	4
21	20 22 24	4

(Size in Inches)



Gold WDH

# PLATE BASKET

The Craft Plate Basket is the accompaniment and concise storage of the Thali Basket, the perfect storage for often used utensils secured by arch structures over a sheet or wire base of your choosing. Sizes available from 12 to 21 inches.



Width	Depth	Height
15	20	6 8
17	20	6 8
19	20	6 8
21	20	6 8

(Size in Inches)

Platinum WDH Available in Sheet & Wire Base

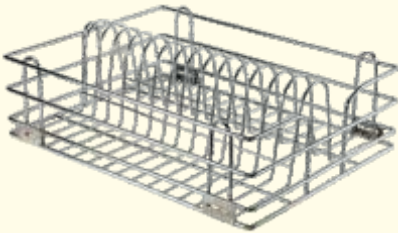

Width	Depth	Height
12	20	6 8
15	16 20 22 24	6 8
17	20 22 24	6 8
19	20 22 24	6 8
21	20 22 24	6 8

(Size in Inches)

Premium WDH

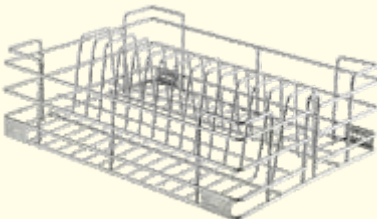

Width	Depth	Height
12	20	6 8
15	16 20 22 24	6 8
17	20 22 24	6 8
19	20 22 24	6 8
21	20 22 24	6 8

(Size in Inches)

Gold WDH

## THALI BASKET

The Craft Thali Basket is all prepped to become the most used installation in urban Indian kitchen. The large platter storage allows minimal space wastage while maximizing good care of your utensils with the non-toxic material build and minimal design. Available in the sizes 12 to 21 inches for both Sheet Base and Wire Base modules.

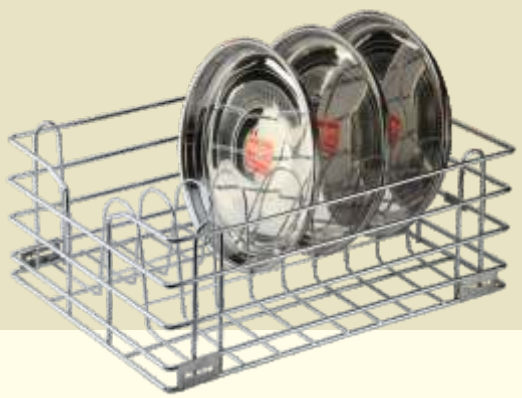

Width	Depth	Height
15	20	6 8
17	20	6 8
19	20	6 8
21	20	6 8

(Size in Inches)  
Platinum WDH Available in Sheet & Wire Base



Width	Depth	Height
12	20	6 8
15	16 20 22 24	6 8
17	20 22 24	6 8
19	20 22 24	6 8
21	20 22 24	6 8

(Size in Inches)  
Premium WDH

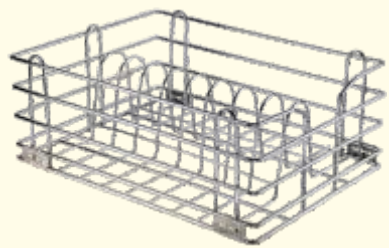

Width	Depth	Height
12	20	6 8
15	16 20 22 24	6 8
17	20 22 24	6 8
19	20 22 24	6 8
21	20 22 24	6 8

(Size in Inches)  
Gold WDH

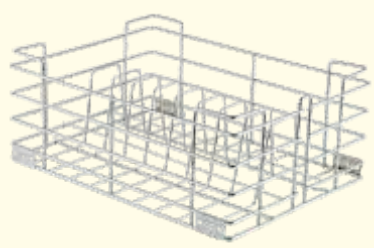

# GLASS BASKET

The Craft Glass Basket is the finale of utensil storage solution, a neat idea design brought to reality by experts at Craft with a drip dry feature for standard size glasses. Available in Wire and Sheet Base Variety.

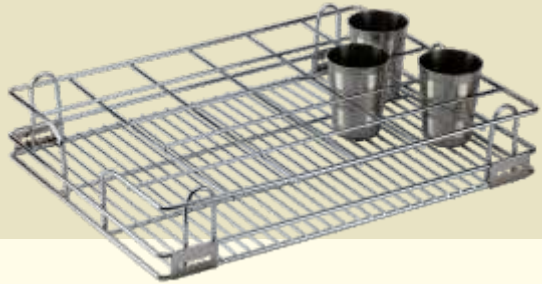

Width	Depth	Height
15	20	4
17	20	4
19	20	4
21	20	4

(Size in Inches)

Platinum WDH Available in Sheet & Wire Base

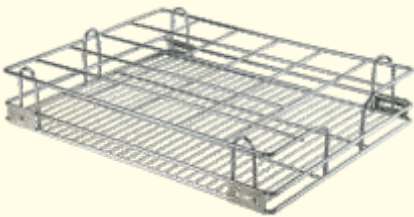

Width	Depth	Height
12	20	4
15	16 20 22 24	4
17	20 22 24	4
19	20 22 24	4
21	20 22 24	4

(Size in Inches)

Premium WDH

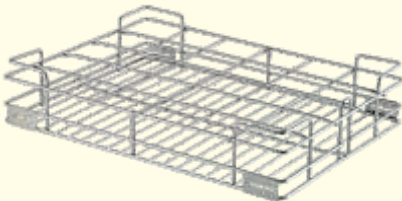

Width	Depth	Height
12	20	4
15	16 20 22 24	4
17	20 22 24	4
19	20 22 24	4
21	20 22 24	4

(Size in Inches)

Gold WDH



## BOTTLE BASKET

Extending its reach to cater to every possible need, the Bottle Basket is the perfect utility tool to install near your water pot or refrigerator to ensure you'll never go thirsty. With a high partition mesh to keep the bottles in place, The Bottle Basket ensures complete product satisfaction with its easy to install and long term performance features. Available in size 12 to 21 inches and in Sheet and Wire base variety.



The Craft Bottle Basket is the testimony of Craft's meticulous attention to nuances of a kitchen need spectrum and provide the perfect utility installation for your Beverages. A raised partition maze which secures bottles, the bottle basket comes in Sheet and Wire Base features in size 12 to 21 inches.

Width	Depth	Height
15	20	6
17	20	6
19	20	6
21	20	6

(Size in Inches)



Platinum WDH Available in Sheet & Wire Base

Width	Depth	Height
12	20	6
15	16 20 22 24	6
17	20 22 24	6
19	20 22 24	6
21	20 22 24	6

(Size in Inches)

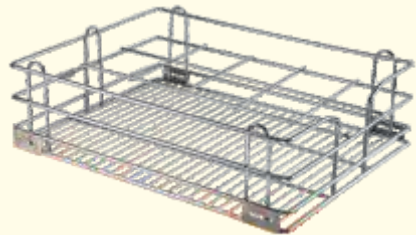

Premium WDH

Width	Depth	Height
12	20	6
15	16 20 22 24	6
17	20 22 24	6
19	20 22 24	6
21	20 22 24	6

(Size in Inches)

Gold WDH



## VEGETABLE BASKET

The Craft Vegetable Basket incorporates the customization of plain storage space and a leveled partition frame work to ensure ease of access for your produce while keeping them fresh with the non-toxic user friendly design. Available in Sheet/Wire Base Variety in sizes from 12 to 21 inches.

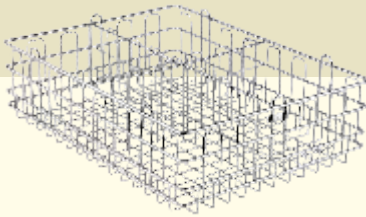
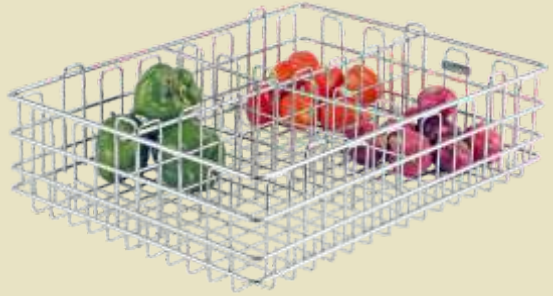

**With Square Partition**

**Vegetable Basket WDH**

Width	Depth	Height
15	20	6
17	20	6
19	20	6
21	20	6

(Size in Inches)

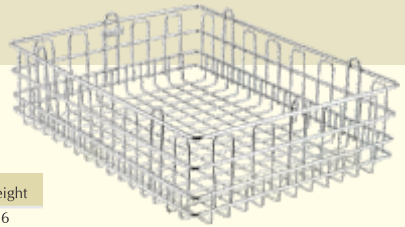

**Plain Basket**

## GRAIN TROLLEY

Presenting The Craft Grain Trolley, a unique combination of strength and space attributes that provides the perfect platform for large size grain storage cans. Installation recommended near the Cooking area for ease of access. Available in Wire and Heavy Base Variety with size range of 12 to 21 Inches.



**Grain Trolley Basket & Mechanism WDH**



Width	Depth	Height
15	20	10
17	20	10
19	20	10
21	20	10

(Size in Inches)

## LARGE UTENSIL BASKET

The ultimate intelligent design in utility accessory, Large Utensil Basket is an aesthetically and functionally sound solution to your dilemma of storing utensils that take up a lot of space while allowing proper segregation and easy accessibility. The Large Utensil Basket is a gem in the CRAFT product range. Available in size 24 to 32 inches.



Width	Depth	Height
24	20	4 6 8
28	20	4 6 8
32	20	4 6 8

(Size in Inches)

Large Utensil Basket WDH

## KITCHEN POLE SYSTEM

Easy to install, economical and non-toxic user friendly partition system made of Stainless steel to ensure long term quality performance, the Kitchen Pole system is easy to install, customizable assembly system with minimum wood required and can be adjusted to the height of 75 mm. In order to ensure perfect stability The Kitchen Pole System is brass tapped to perfection.

Craft presents modern kitchen partition system which is easy to use and economical also.

### Features :

- Stainless steel material for long life.
- Easy to fit and can be assembled easily.
- Different size of cabinet can be easily made.
- Minimum wood requirement.
- Height can be adjusted up to 75mm.
- Brass tapped bushes Ensure the firm fitment.

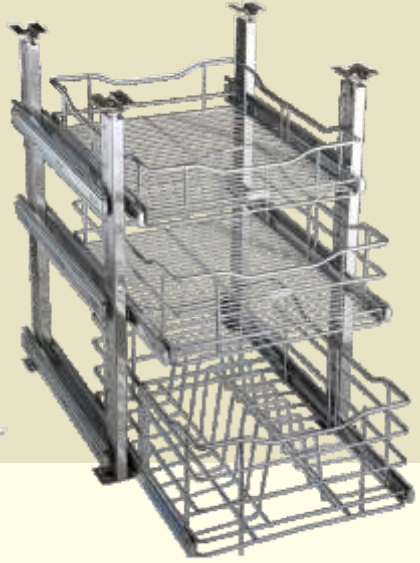

Kitchen Pole System

Total Height	27" + 3" adjustable
Width	20 mm
Depth	50 mm
Hole Distance	32 mm

## OUR STORY



Every Craft Product is carefully created with the dimensions providing and achieving the singularity between ease of installation and ease of use. With the urban interiors rapidly changing, it is necessary to devise ways for the storage appliances to not only grow in terms of ability but also in terms of availability. Craft Product line ensures this very notion in work by providing dimensions perfectly suited for the modern urbanity, offering customization and versatility.



The Craft Product Line is highly recommended for the urban interiors for the high artistic form of its versatility. As a Designer, Craft is the go to solution for finding the balance between achieving a utilization balance between the appearance and function. The Design in itself is incredibly fashionable with its sleek chrome edges, giving a sense of modernity, while the dimensions and structure conveys the assurance of long term quality and stability.



As a Chef, I often experiment with ingredients. And it is not an easy to manage several different dishes cooking at the same time, be it keeping a track of time or ingredients. The Craft Products allow me perfect arrangements for both. While the products installed take up very little space, the marvelous versatility of the uses and complete ease in arrangement due to the design and dimensions allows for a much more pleasurable cooking session. I can now easily remember and turn to just the ingredient I am looking for without the hassle of wasting time.

---

**Er. Vijay Agrawal**  
Architect

**Saify Bootwala**  
A leading Businessmen

**P. Anthony**  
A CRAFT user

# HANGING & MULTIPURPOSE ACCESSORIES

## PIPE HANGING ACCESSORIES

Hanging Ladle Cradle/Cup and Saucer/Knife and Fork Holder/Glass Holder/Hanging Utility Rack  
A bouquet of hanging-style solutions to provide easy storage space and maximized kitchen space economy, the Hanging Storage systems are the perfect solutions for organizing your utensils and cutlery.



**Hanging Cup & Saucer**

Width	Height
12	12

(Size in Inches)



**Hanging Ladle Cradle**

Width	Height
20	17

(Size in Inches)



**Hanging Utility Rack**

Width	Height
16	10

(Size in Inches)



**Hanging Knife & Fork Holder**

Width	Height
6	10

(Size in Inches)



**Hanging Glass Holder**

Width	Height
13	18

(Size in Inches)



## HANGING CORNER ONE & TWO SHELF

Perfect fixture for the corner space dimensions, CRAFT Hanging Corner One and Two Shelf allows for easy access and storage of your daily items to ensure you never have to worry about efficiency or space wastage.



**Hanging Corner One Shelf**

Width	Height
11	14

(Size in Inches)



**Hanging Corner Two Shelf**

Width	Height
11	14

(Size in Inches)

**Hanging Paper & Foil Holder**

Width	Height
12	14

(Size in Inches)



**Paper and Foil Holder**

A simple support structure with solid frame that ensure long term performance, CRAFT Paper and Foil Holder Utility Corner provides complete accompaniment to your kitchen needs.

### Hanging Multipurpose One/Two Shelf

A doubled designed for providing the universal storage apparatus with easy to install features and perfect accessibility.



**Hanging Multipurpose One Shelf**

Width	Height
14	11

(Size in Inches)



**Hanging Multipurpose Two Shelf**

Width	Height
14	15

(Size in Inches)

# HANGING & MULTIPURPOSE ACCESSORIES

## UTILITY RACK

From Wall-mounted to simple stands and adjustable unit systems, The CRAFT Utility Rack is a collection of perfect addition to your kitchen's storage needs to ensure easy and versatile solution. Designed to sleek perfection with non-toxic, user-friendly materials and optimizing the space availability.

Also available in multi-rack designs and specific utility designs such as Wine and Fruit racks.



**Wall Mounted Rack**

Width	Height
18	18

(Size in Inches)



**Dish Stand**

Width	Height
18	12

(Size in Inches)



**Glass Tray Plate Tray**

Width	Height
16	10
18	10
20	10
22	10
24	10
28	10
30	10
34	10

(Size in Inches)

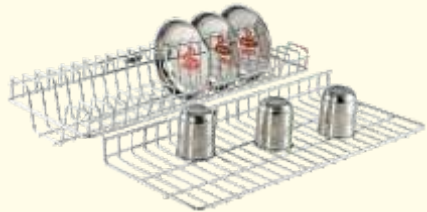

## AVAILABLE OPTIONS

- Glass Tray & Plate Tray
- Cup and Saucer Stand
- Kitchen Keeper
- Small Organizer
- Plate Holder
- Ladle Cradle
- Sink Tray



**Small Organizer**

Width	Height
8	8

(Size in Inches)



**Plate Holder**

Width	Height
8	8

(Size in Inches)

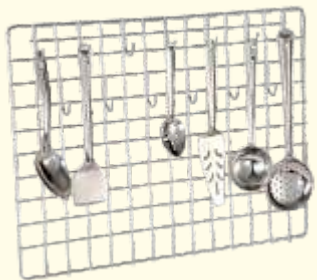

**Ladle Cradle**

Width	Height
20	15

(Size in Inches)

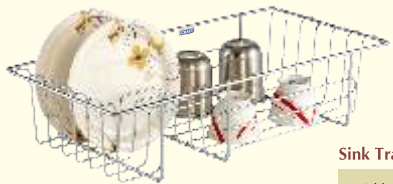

**Sink Tray**

Width	Height
20	5

(Size in Inches)



**Cup & Saucer Stand**

Width	Height
12	15

(Size in Inches)



**Kitchen Keeper**

Width	Height
14	16

(Size in Inches)

# HANGING & MULTIPURPOSE ACCESSORIES

## AVAILABLE OPTIONS

- Multi Rack-1/2/3 Shelf
- Spice Rack
- Wine and Bottle
- Right Rack
- Bottle Rack



**Corner Rack 3 Shelf**

Width	Height
11	22

(Size in Inches)



**Corner Rack 1 Shelf**

Width	Height
11	3

(Size in Inches)



**Corner Rack 2 Shelf**

Width	Height
11	15

(Size in Inches)



**Multi Rack 3 Shelf**

Width	Height
14	22

(Size in Inches)



**Multi Rack 1 Shelf**

Width	Height
14	6

(Size in Inches)



**Multi Rack 2 Shelf**

Width	Height
14	12

(Size in Inches)

AVAILABLE OPTIONS

- Corner Rack 1/2/3-Shelf
- Fruit Basket and Rack
- Hot Stand

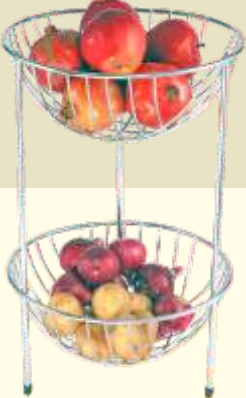

**Fruit Rack**

Width	Height
10	16

(Size in Inches)

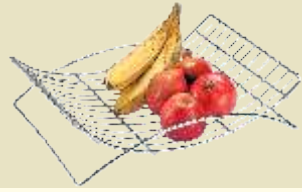

**Fruit Basket**

Width	Height
14	11

(Size in Inches)



**Hot Stand**

Width	Height
12	8

(Size in Inches)



**Bottle Rack**

Width	Height
8	12

(Size in Inches)



**Spice Rack**

Width	Height
12	6

(Size in Inches)



**Wine Rack**

Width	Height
21	9

(Size in Inches)



**Right Rack**

Width	Height
14	4

(Size in Inches)

# HANGING & MULTIPURPOSE ACCESSORIES

## AVAILABLE OPTIONS

- Microwave Stand
- Wine Glass Holder
- Magazine Shelf
- Multi Purposes Office Rack
- CD Rack
- Mobile Stand



**Wine Glass Holder**

Width	Height
13	2.5

(Size in Inches)



**Microwave Stand**

Width	Height
21	12

(Size in Inches)



**Mobile Stand**

Width	Height
-	-

(Size in Inches)



**CD Rack**

Width	Height
7	14

(Size in Inches)



**Multipurpose Office Rack**

Width	Height
11	6

(Size in Inches)



**Magazine Shelf**

Width	Height
4	8

(Size in Inches)





## HANGING & MULTIPURPOSE ACCESSORIES

### BELOW THE SINK

CRAFT Below The Sink product range comes equipped with utility designs that allow perfectly seamless merging with your kitchen cleaning space and enhancement of facility in order to optimize utilization.



**Detergent Pull Out**

Width	Height
6	17

(Size in Inches)

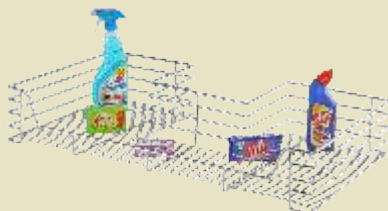

**Under Sink Basket**

Width	Height
32	20

(Size in Inches)



**S.S. Dust Bin**

Width	Height
-	-

(Size in Inches)



**Bin Holder**

Width	Height
11	6

(Size in Inches)



**Use me**

Width	Height
12	13

(Size in Inches)



**Detergent Holder**

Width	Height
10	17

(Size in Inches)

## MULTIPURPOSE POLE SYSTEM

Presenting the stylishly convenient CRAFT Multipurpose Pole System. An innovation that allows the perfectly stylized storage system for your wines, glasses, tumblers, and a base fruit tray to provide one stop solution for the quick refreshments. The strong user friendly wire based frame provides complete support to your delicate wine glasses while ensuring proper storage structure for the precious bottles. The base fruit tray enhances the utility options by providing a storage space with maximum storage options.



## BATHROOM ACCESSORIES

CRAFT Bathroom range allows a vast variety of utility solutions ranging from Towel Shelves to Towel Rods, Bath Utility Rack for your cosmetics, Bathroom corner Rack 1/2 Shelf systems and Toilet Paper. Designed with non-toxic user friendly materials the CRAFT Bathroom Accessories are the perfect enhancement to your requirements.



**Towel & Napkin Holder**

Width	Height
6	3

(Size in Inches)

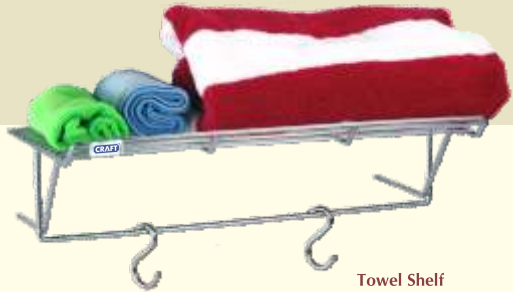

**Towel Shelf**

Width	Height
18	10

(Size in Inches)



**Bathroom Utility Rack**

Width	Height
10	18

(Size in Inches)



**Towel Rod**

Width	Height
23	4

(Size in Inches)

## AVAILABLE OPTIONS

- Towel Shelf
- Towel & Napkin Holder
- Towel Rod
- Bathroom Utility Rack
- Bathroom Corner Rack
- Multipurpose Shelf
- Soap Dish
- Toilet Paper Holder



**Bathroom Corner Rack 1 Shelf**

Width	Height
11	3

(Size in Inches)



**Bathroom Corner Rack 2 Shelf**

Width	Height
11	15

(Size in Inches)



**Multipurpose Shelf**

Width	Height
14	6

(Size in Inches)



**Toilet Paper Holder**

Width	Height
-	-

(Size in Inches)



**Soap Dish**

Width	Height
-	-

(Size in Inches)





## WARDROBE ACCESSORIES

CRAFT Wardrobe Accessories Range includes convenient standalone and customizable assembly units such as Hanger Holders, Wardrobe Basket, Hook Racks, Perfume Racks, Saree Slider, Multipurpose Wardrobe Rack, Shoe Rack and Hangers. Combining stability and style with aesthetic design and non-toxic user friendly materials, these assembly and standalone units can be utilized with maximizing space and storage usage with minimal troubles.



**Trouser & Saree Slider**

Width	Depth
32	20

(Size in Inches)



**Hanger Holder**

Width	Height
20	6

(Size in Inches)



**Wardrobe Basket**

Width	Depth
32	20

(Size in Inches)



**Multipurpose Wardrobe Basket**

Width	Depth
14	20

(Size in Inches)



**Perfume Rack**

Width	Height
12	4

(Size in Inches)



**Saree Slider**

Width	Height
-	-

(Size in Inches)

## WARDROBE ACCESSORIES



**Multi Wardrobe Rack**

Width	Height
12	14

(Size in Inches)



**Multipurpose Shelf**

Width	Height
12	18

(Size in Inches)

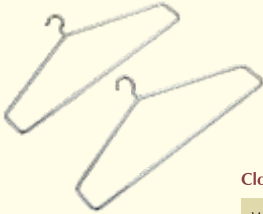

**Cloth Hanger**

Width	Height
-	-

(Size in Inches)



**Bangle Holder**

Width	Height
6	18

(Size in Inches)



**Shoe P/O Rack**

Width	Height
-	-

(Size in Inches)



**Shoe Rack**

Width	Height
31	16

(Size in Inches)



**DONATE EYES**



**ADD LIFE TO THEIR LIVES**

**CRAFT**<sup>®</sup>

*Crafting Happiness*

In keeping with our matter of resurvey item design, up gradation and material may change without prior notice. No part of this catalogue whole or in part may be reproduce or utilised in any form or by any means without written consent from Craft. \*Conditions apply Product image shown in the catalogue is just an impression, original product may be different from it. Error and omissions expected. Subject to Indore jurisdiction only.



Should there be anything we can do for you.  
Please feel free to contact us...



*Crafting Happiness*

E-mail : [info@craftawp.com](mailto:info@craftawp.com)  
Website : [www.craftawp.com](http://www.craftawp.com)

DEALER / DISTRIBUTOR

